

MiraFount



**INSTALLATION INSTRUCTIONS AND
SPECIFICATIONS FOR MODEL 3465-E**

READ CAREFULLY

MIRACO

A DIVISION OF
AHRENS AGRICULTURAL INDUSTRIES, INC.

BOX 686

GRINNELL, IOWA 50112

PHONE 641-236-5822

TOLL FREE 1-800-541-7866

FAX 1-641-236-3341

Website: www.miraco.com

SPECIFICATIONS

PART 1 - GENERAL

A. DESCRIPTION:

1. The MiraFount is the finest operating, lowest cost, energy-free livestock waterer on the market today. The sealed atmosphere helps prevent the formation of scum and algae. It also prevents tongue injuries from contact with frigid steel.
2. The earth temperature of the water will keep your MiraFount flowing in cold weather and also keeps the water cool in hot weather. Thermal engineering and special design of the lid closures make it work in all types of weather.
3. All edges are curved and sloped to prevent injury to people and animals. No energy is required, eliminating the danger of electrocution and fire hazards.

B. WEIGHTS & DIMENSIONS

Model #	Capacity	Gallons	Description	Dimensions	Weight
3465-E	* 100 hd. beef * 40 hd. dairy	20	2-9 ¹ / ₄ " openings ball closures	24" x 36" x 18"	84#

C. MATERIAL NECESSARY FOR INSTALLATION:

1. Concrete
2. P.V.C. Glue
3. #834 insulated tube
4. Thread sealer or teflon tape



PART II - MATERIALS, PRODUCTS

A. MATERIALS:

1. High impact Rockite™ polyethylene.

B. INSULATION:

1. The base, cover and lid closures are filled with a 3" thickness of Urethane foam.

C. VALVE:

1. Miraco valve with brass rod and ends.

COMMON SENSE MANAGEMENT TIPS TO CONSIDER WHEN BUYING AN ENERGY FREE WATERER:

- #1 A minimum of 20 head of livestock need to be using the waterer during subzero weather.
- #2 Water lines must be buried well below the frost line so incoming water is at least 42°.
- #3 You must use an insulated heat well or supply a low wattage heat tape on the water line in areas where frost goes below 21" deep. The heat well must be free of water above the frost line.
- #4 The MiraFount must be the primary source and livestock should have access to the waterer at all times.
- #5 If less than 20 head of livestock are going to use this tank and your weather gets below zero for extended periods, then the E-fount should be your choice.

MIRAFOUNT #3465-E INSTALLATION INSTRUCTIONS

NOTE: For cold climates, insulate the upper portion of your heat well, or use the model #834 heat well by Miraco.



Step 1

Install your heat well at least 1' below frost or down to your water line to insure frost free operation. Install the water line so it comes up close to the center of the heat well. Always allow the cement to harden at least 72 hours before you continue to next steps. Place the pipe insulation over the fill line leaving it about 4" above the cement and pull the nylon tie tight so the insulation doesn't slip down.

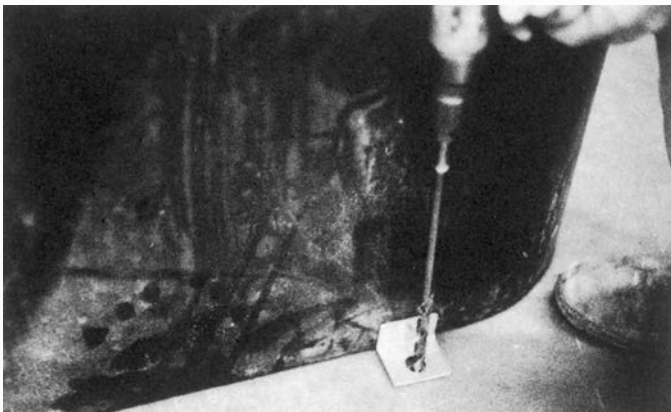

Step 3

Place the tank over the fill line and position the tank so the fill line is centered in the pit. Using a $\frac{3}{8}$ " cement drill, drill the anchor holes. Note on some tanks it is necessary to be off center a little to make sure the tank covers the hole.

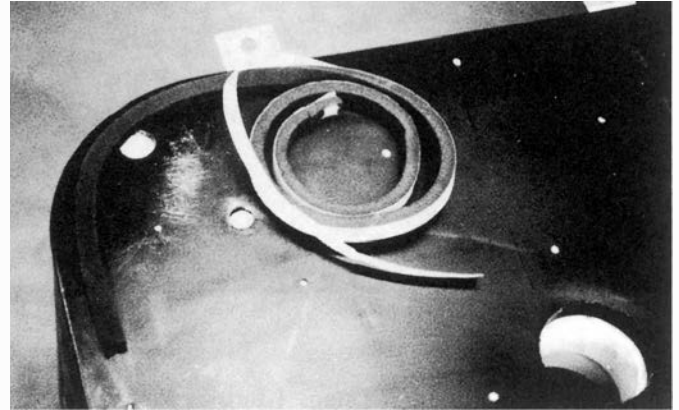

Step 2

Pull the paper backing off the rubber gasket furnished in your parts carton. Stick this gasket on the bottom of your tank. Keep the gasket as close to the edge as possible. This is necessary to keep air out and keep your heat well dry.



Step 4

Drive the anchor bolts in and tighten evenly.

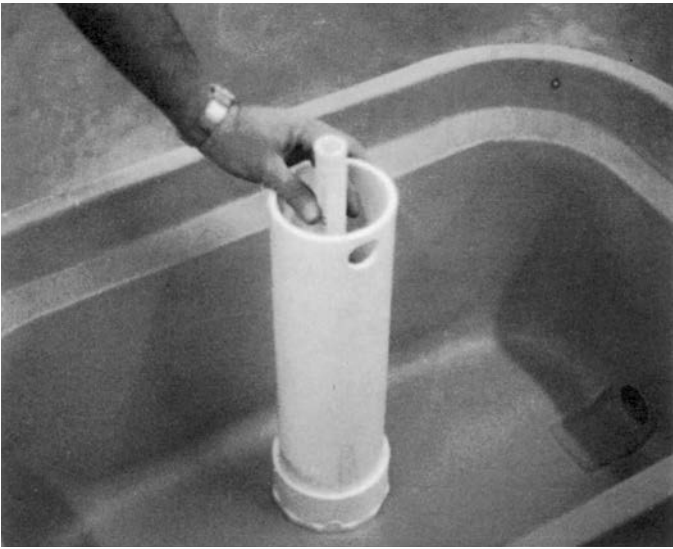

Step 5

After you have completed steps 1 thru 3, your fill line will be standing above the 4" riser pipe. Make sure the pipe is pushed completely down into the bottom fitting.

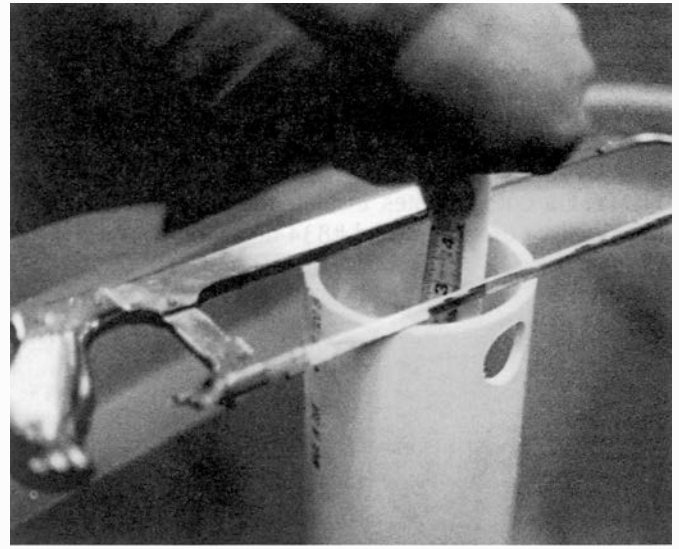

Step 6

With a pen or pencil, make a mark on the fill line $2 \frac{3}{4}$ " below the top of the 4" outer pipe.

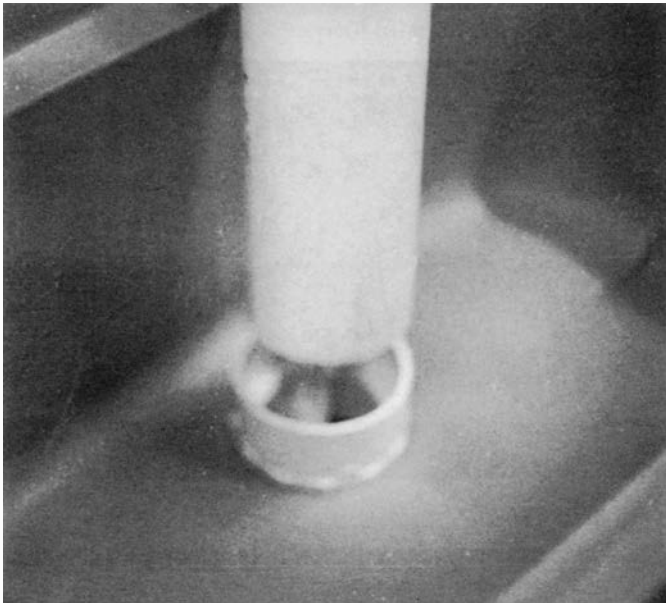

Step 7

The riser pipe is not glued into the bottom fitting. Pull the riser pipe out of the bottom fitting.

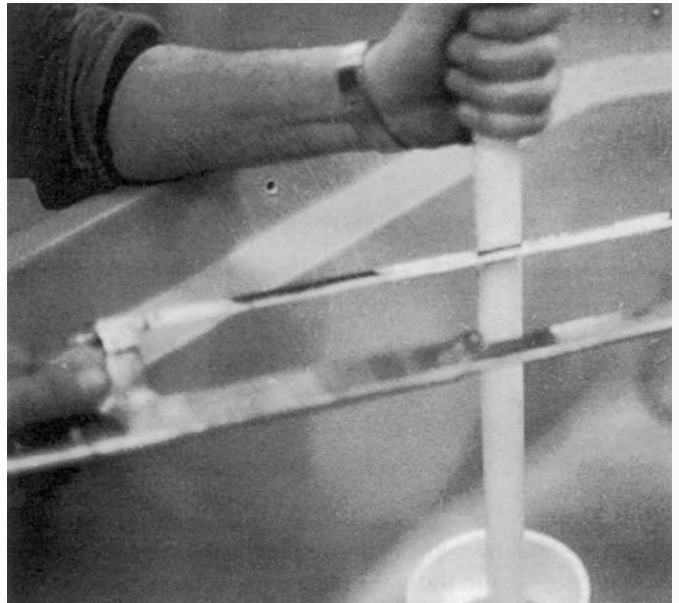

Step 8

With a hack saw, cut off the fill line where you made your mark previously.



Step 9

The pipe insulation should be up into the tank about 2". If you are using a low wattage heat tape to protect the water line, do not use the pipe insulation.

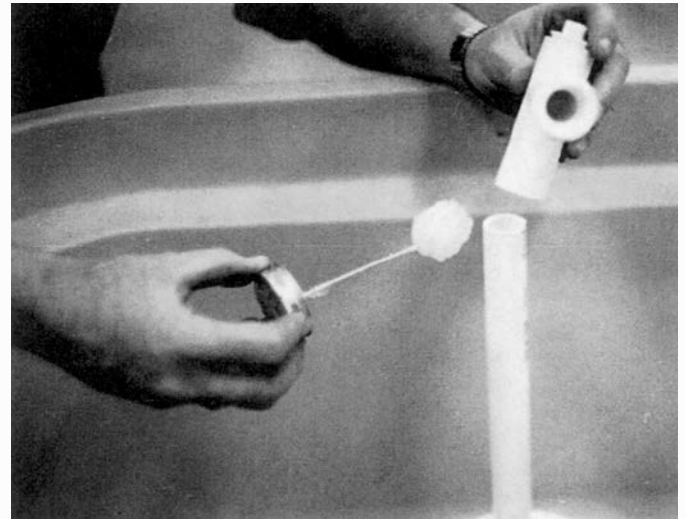

Step 10

After applying thread sealer on the plug in the 3/4" "T," glue the "T" assembly to the fill line with the threaded fitting pointed at the opposite wall of the tank farthest away from the line.



Step 11

Make any adjustments before the cement sets up.



Step 12

Using the same PVC cement, apply it to the bottom of your 4" riser pipe. Make sure all connections are clean before applying glue.



Step 13

After PVC cement has been applied, push the riser pipe into the bottom fitting and align with the "T" fitting so the "T" fitting fits into the 1 $\frac{1}{4}$ " hole at the top of the riser pipe. Push the 4" pipe down completely to the bottom of the fitting.

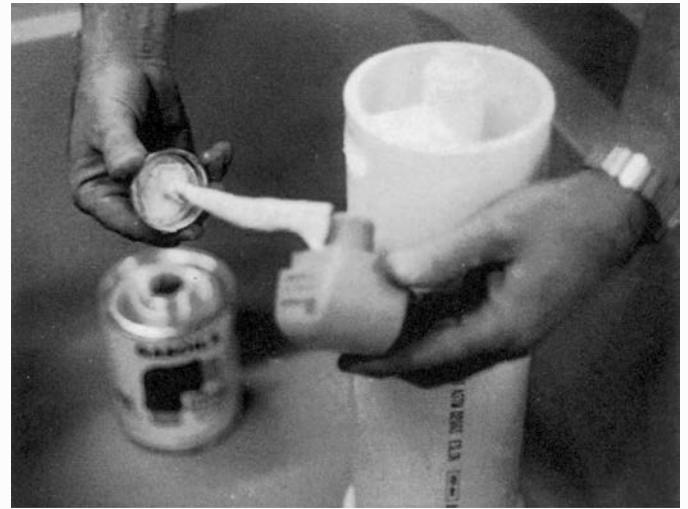

Step 14

Apply plumbers pipe cement to the valve threads or use teflon thread sealer.



Step 15

Screw the valve into the "T" fitting so the valve is tight. In most cases, hand tight is sufficient. If wrenches are required, be careful not to over tighten. Valve should be straight up and down when tightened. Valve should be back tight against the 4" 1185 riser pipe.



Step 16

Install the bob float and arm with the brass thumb screw. When the water level is at the proper setting, the horizontal arm should be parallel with the water and the vertical arm should be screwed up until the bob float is within $\frac{3}{8}$ " of the nylon fitting.



Step 17

Apply pressure down on the top and screw in the base bolts to secure the top to the base. If the holes don't line up don't be concerned. The bolt will make its own hole.

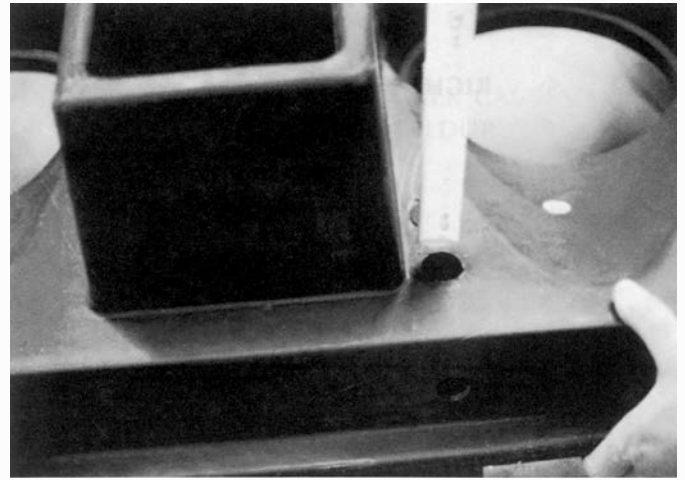

Step 18

If you are dairy (dairy only) remove the 2 rubber plugs in the top portion of the tank. Then place the $\frac{3}{4}$ " pipe in the bottom hole. The 45° angle goes in the hole. Align so water can pass thru.

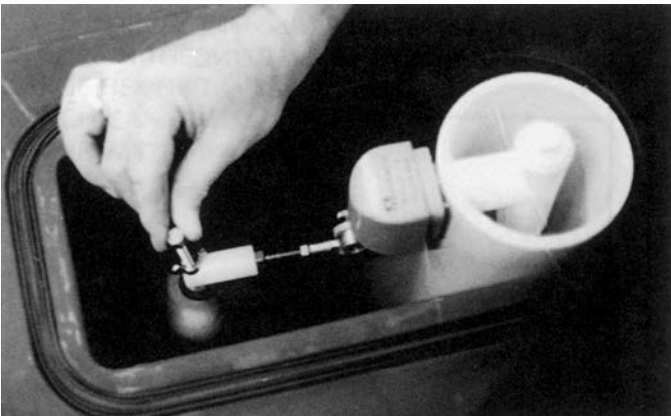

Step 19

All water adjustment can be done by turning the vertical arm up or down thru the top access.



Step 20

Always place the drain plugs in from the inside to prevent them from coming out.

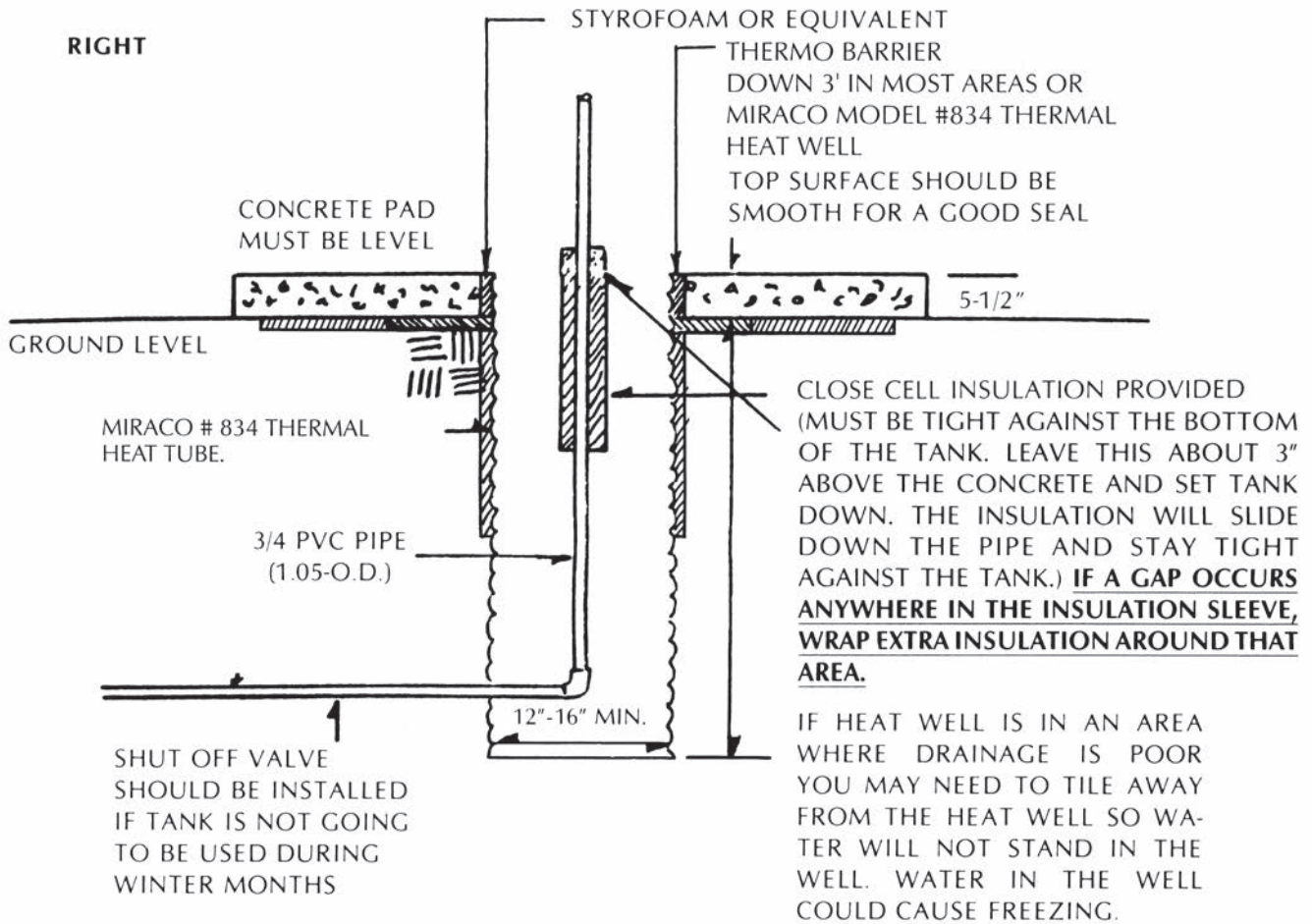

BASE AND ANCHOR PLATE DIMENSIONS MODEL 3465-E

DRILL ANCHOR BOLTS IN AFTER SETTING TANK. USE 3/8" CEMENT DRILL

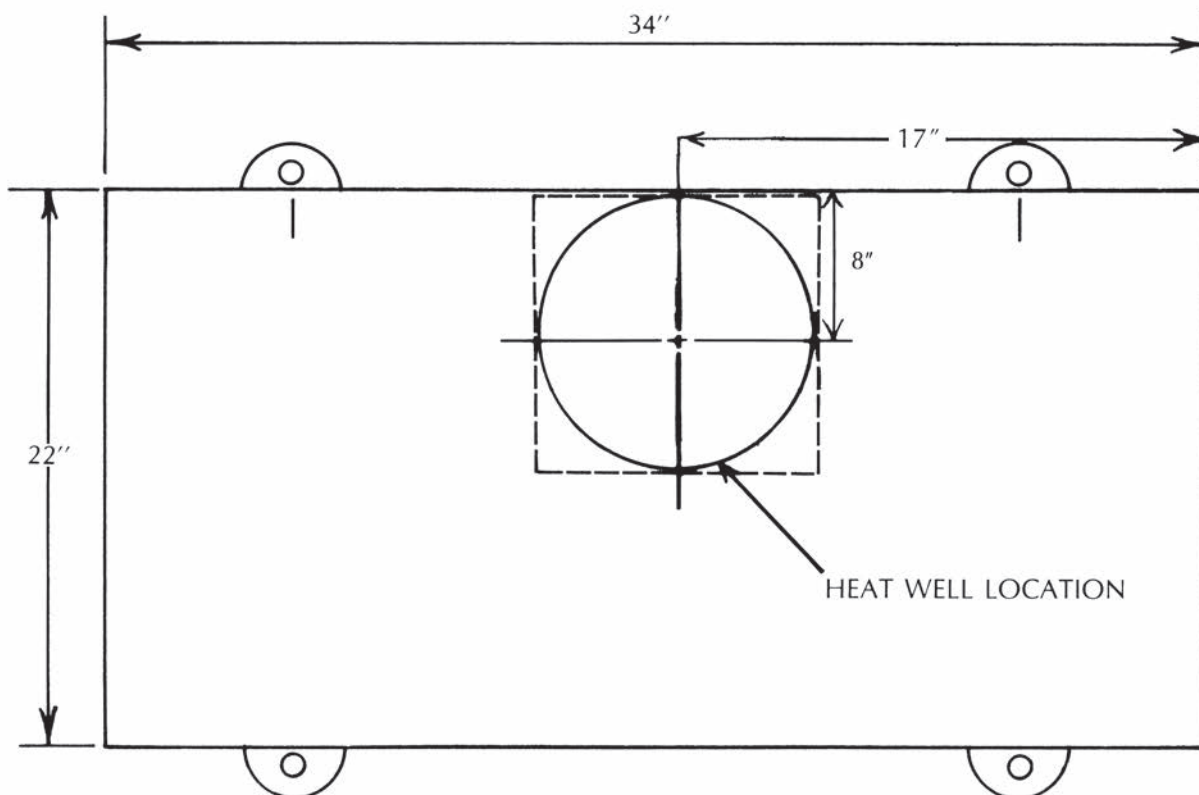

MODEL 3465-E

WRONG

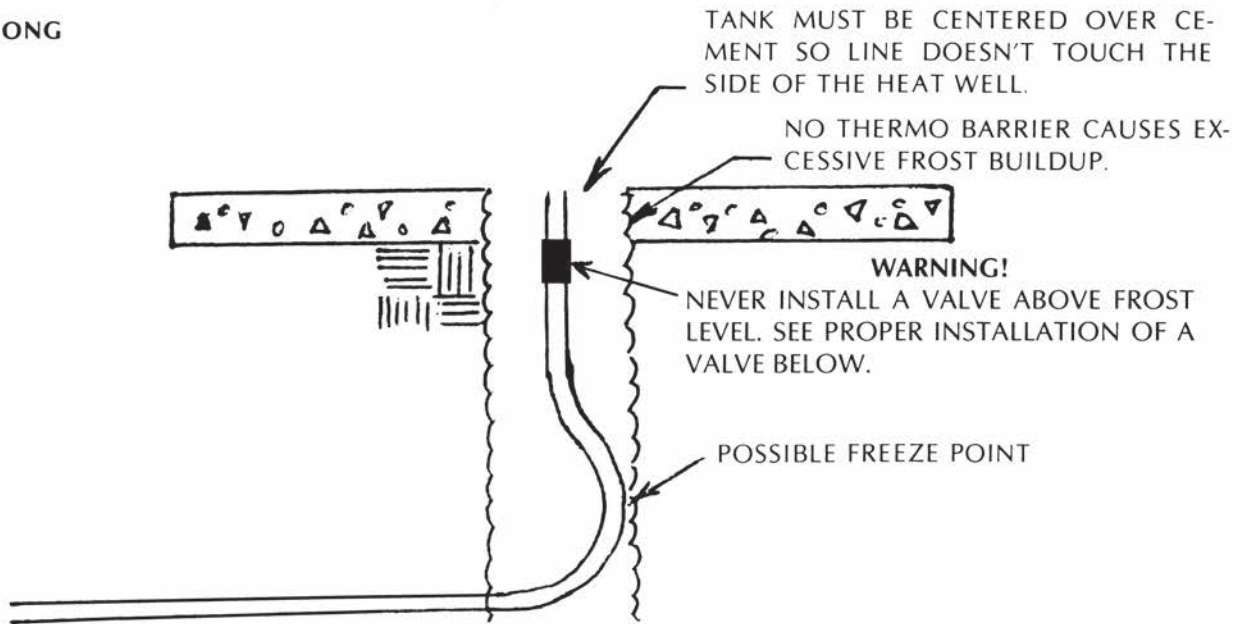

PROPER INSTALLATION OF DRAIN BACK SHUTOFF VALVE

RUN THIS ROD THROUGH THE VENT PIPE IN THE WATERER. WELD A LARGE HEX NUT ON TOP, SO A WRENCH CAN BE USED TO SHUT OFF THE WATER BELOW.

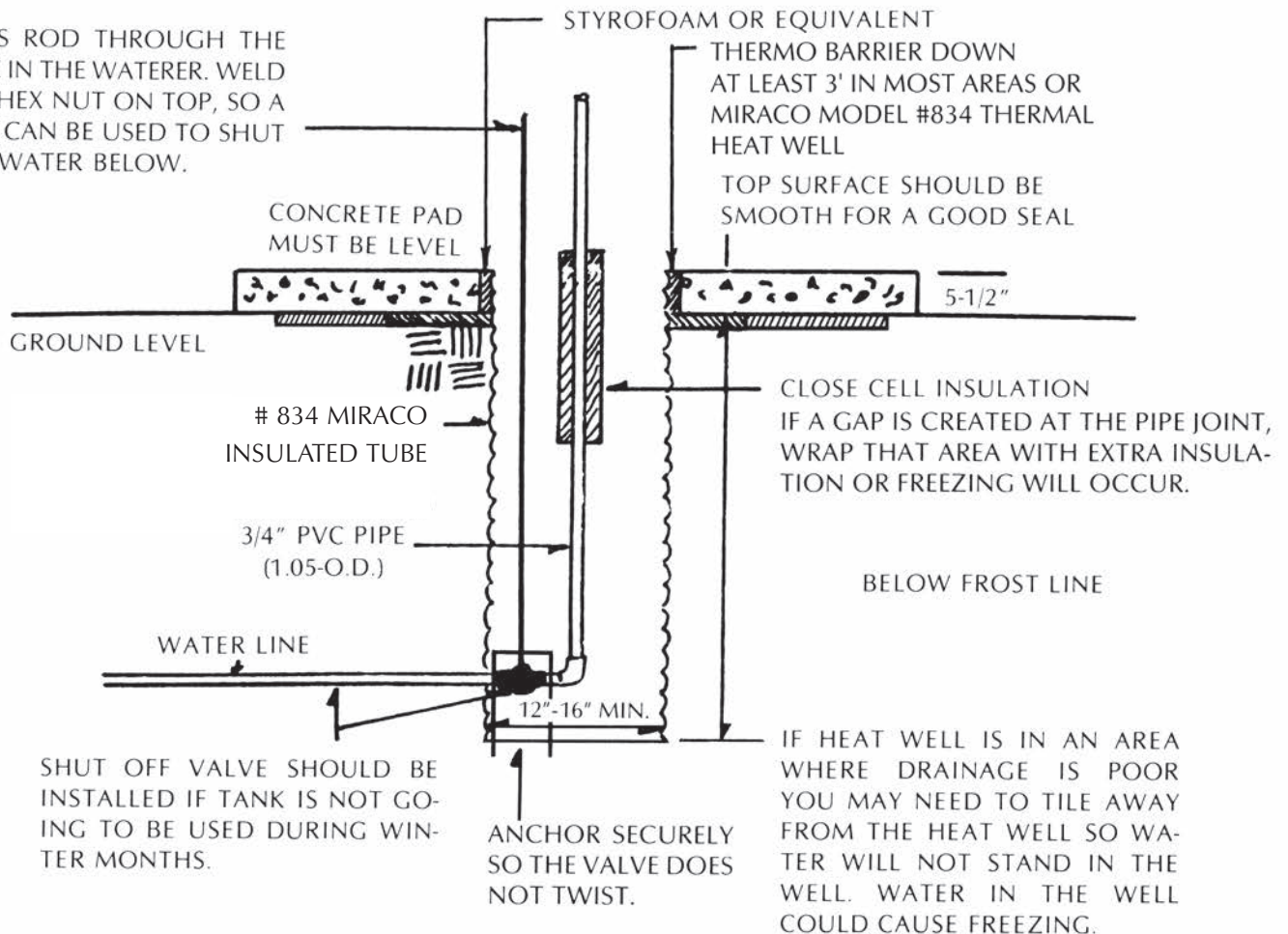

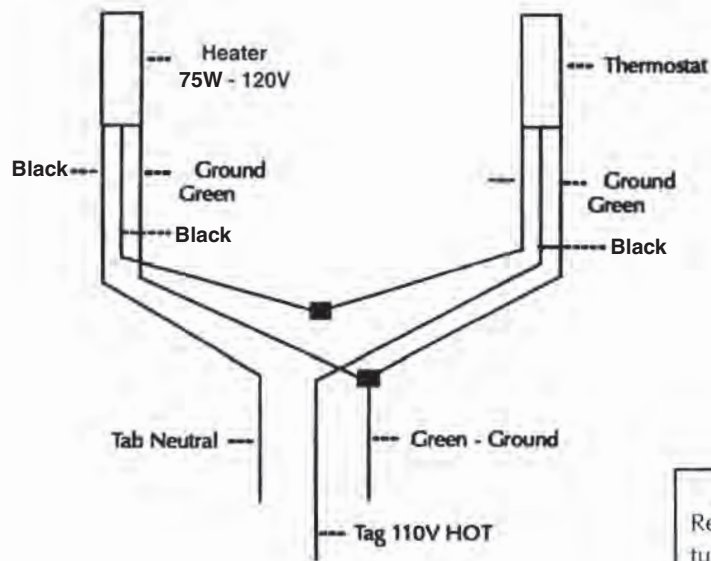

CAUTION
Read instructions carefully and turn electricity off at main fuse box before beginning installation.

FIELD CONNECTIONS

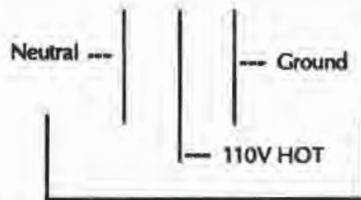

ELECTRICAL CONNECTION—Electrical service must be made and maintained by a qualified electrician. Each fountain must be wired through a fuse box with proper sized wire. (Refer to access plate for electrical requirements.) Hot wire must be run through the thermostat, and the neutral wire run to the white wire or neutral marked wire in junction box. A copper ground rod, buried in a minimum of 10' in soil, must be provided at each fountain. Connect ground wire from rod to ground connection in junction box.

THERMOSTAT—Preset at the factory for 50°.

WARNING—NEVER ALLOW THE E-FOUNT TO SET EMPTY UNLESS THE HEATER HAS BEEN TURNED OFF. ALWAYS DISCONNECT ELECTRICITY TO THE E-FONT BEFORE DRAINING. DAMAGE TO THE TANK CAN OCCUR.

WARNING: THIS INSTALLATION MUST BE MADE AND MAINTAINED IN STRICT CONFORMITY WITH NATIONAL/LOCAL PLUMBING CODES AND NATIONAL/LOCAL ELECTRICAL CODES (CSA IN CANADA). THE APPLICABLE PROVISIONS OF THESE CODES TAKE PRECEDENT. FAILURE TO MAKE AND MAINTAIN ALL INSTALLATIONS PROPERLY MAY RESULT IN LOSS OF LIVESTOCK, PERSONAL INJURY, OR DEATH.

NOTICE: CANADIAN ELECTRICAL CODE—PART 1 REQUIRES LIVESTOCK WATERERS INSTALLED IN FEEDLOTS IN OPEN FEEDING AREAS SHALL BE GROUNDED BY A SEPARATE COPPER GROUNDING CONDUCTOR OR AT LEAST NO.6 AWG TERMINATING AT A POINT WHERE THE BRANCH CIRCUIT RECEIVES ITS SUPPLY.

Miraco Livestock waterers Express warranty and Waiver of implied warranties and consequential damages

Express Warranty

Ahrens Agricultural Industries Co. , dba Miraco, expressly warrants that the Miraco waterers (excluding valve and valve parts) will be free of defects in materials and workmanship for a period of five (5) years from delivery. The Miraco valve and valve parts are warranted to be free of defects in materials and workmanship for a period of one (1) year from delivery. Such warranty does not apply to any Miraco unit that has been subjected to misuse, or material failure to install, operate or maintain in accordance with Miraco's written instructions, or other events acts or omission, including but not limited to acts of nature, which affect the Miraco unit materially and adversely and are not attributable to Miraco.

This warranty is limited to the repair or replacement of the defective part, at the option of Miraco. Such repair or replacement part is warranted only for the unexpired portion of the original warranty period. Buyers with warranty claims should contact their local dealer immediately.

Heaters in all electrically heated units are warranted for a period of one (1) year.

Waiver of implied warranties and Consequential damages

Except for the above express warranty, this product is sold as is. Implied warranties of merchantability and fitness for a particular purpose, as well as special, indirect or consequential damages, are all waived by the buyer.

MODEL #3465-E

MANAGEMENT TIPS

1. A 1/4" bolt is to be used to hold the balls back for training livestock. The 1/4" bolt is inserted into a threaded insert in the baffled portion of the lid. This holds the balls back for training.
2. For short periods of time when you're not using the MiraFount in winter, you can dip 3-5 gallons of water out every day and the tank will sustain itself until livestock are using it again. If you plan on not using it for a long time, merely drain it and shut off the water. This is where the shut off valve comes in handy.
3. Water level is very important. If the water is too high the balls will stick shut in the winter time and the tank will appear frozen. A kick or small amount of hot water on the balls will fix the problem. Then lower the water level so this won't happen again. However, never lower water below the baffle or cold air could go under and freeze your valve.
4. In case of power failure, merely keep the livestock away from the waterer so they can't drink it down. If this has already happened, then a small amount of hot water is all you need. **NEVER USE AN OPEN FLAME TO THAW ICE!**
5. Management is necessary in any operation and this includes checking your waterer daily. Water is very important and any malfunction should be attended to immediately. This is good practice for any make of waterers.
6. MiraFounts must be installed level, otherwise one ball will be higher than the others.
7. The MiraFount should be cleaned periodically, especially the ones being used for hogs. Mud can hamper the proper operation of the MiraFount since the balls have to move freely in order to have proper operation.
8. If your valve is seeping, check the valve for foreign materials first. This is the biggest cause of seeping valves. If you have extremely rusty water or dirty water, your valve should be cleaned periodically.
9. If you have any questions give us a call at 641-236-5822.
10. If valve persists on leaking, use an allen wrench to tighten the orifice under the plunger. Turn clockwise to tighten.
11. Drain plugs are to be placed inside the tank to plug the drain hole.
- * 12. **Capacities are based on confined cattle. If pasture animals are using this product and have a tendency to come to water all at the same time, extra water space may be needed.**